

## MAHLE ACX2150

EN

Operation Manual  
A/C Service Equipment





# Contents

|           |  |           |
|-----------|--|-----------|
| <b>1</b>  | <b>Symbols use</b> .....                       | <b>4</b>  |
| 1.1       | In the documentation .....                     | 4         |
| 1.1.1     | Warning notices- Structure and meaning .....   | 4         |
| 1.1.2     | Symbols in this documentation .....            | 4         |
| 1.2       | On the product .....                           | 4         |
| <b>2</b>  | <b>Important notes</b> .....                   | <b>4</b>  |
| 2.1       | User group .....                               | 4         |
| 2.2       | Agreement .....                                | 4         |
| 2.3       | Obligation of contractor .....                 | 5         |
| 2.4       | Safety regulations .....                       | 6         |
| 2.4.1     | ACX2150 .....                                  | 6         |
| 2.5       | Safety devices .....                           | 8         |
| 2.6       | Proper disposal .....                          | 8         |
| 2.7       | Recycled material disposal .....               | 8         |
| 2.8       | Packaging disposal .....                       | 8         |
| 2.9       | Disposal of combo filter .....                 | 8         |
| 2.10      | Technical Data .....                           | 8         |
| 2.11      | Glossary .....                                 | 8         |
| <b>3</b>  | <b>Product description</b> .....               | <b>9</b>  |
| 3.1       | Application .....                              | 9         |
| 3.2       | Scope of delivery .....                        | 9         |
| <b>4</b>  | <b>Description of unit</b> .....               | <b>10</b> |
| <b>5</b>  | <b>Input Selection</b> .....                   | <b>12</b> |
| 5.1       | Selection and function key .....               | 12        |
| 5.2       | Display screen .....                           | 13        |
| 5.3       | Main Menu Options .....                        | 13        |
| 5.4       | Unit Features .....                            | 13        |
| 5.4.1     | EcoLOCK <sup>®</sup> couplers (optional) ..... | 13        |
| 5.4.2     | Locking caster brakes .....                    | 13        |
| 5.4.3     | Power supply cable and switch .....            | 13        |
| 5.5       | Functional description .....                   | 14        |
| <b>6</b>  | <b>Equipment installation</b> .....            | <b>15</b> |
| 6.1       | Unpacking ACX2150 .....                        | 15        |
| <b>7</b>  | <b>Commissioning</b> .....                     | <b>16</b> |
| 7.1       | Connections and positioning .....              | 16        |
| 7.2       | First start-up verification .....              | 16        |
| 7.3       | Setup .....                                    | 17        |
| 7.4       | Internal Bottle Fill .....                     | 17        |
| <b>8</b>  | <b>A/C service preparation</b> .....           | <b>18</b> |
| 8.1       | Preliminary preparation .....                  | 18        |
| 8.2       | Non-condensable gas discharge .....            | 18        |
| 8.3       | Charge Modes .....                             | 18        |
| 8.3.1     | Quick Modes .....                              | 18        |
| 8.3.2     | Zero tolerance mode .....                      | 18        |
| <b>9</b>  | <b>A/C system service</b> .....                | <b>19</b> |
| 9.1       | Automatic cycle setup .....                    | 19        |
| 9.2       | Manual cycle setup .....                       | 19        |
| 9.3       | Recovery process .....                         | 20        |
| 9.4       | Vacuum process .....                           | 20        |
| 9.5       | Charge process .....                           | 20        |
| 9.6       | Vehicle Pressure Check .....                   | 21        |
| 9.7       | Unit of measure .....                          | 21        |
| 9.8       | Clock Adjustment .....                         | 21        |
| 9.9       | Setting language .....                         | 21        |
| <b>10</b> | <b>Maintenance</b> .....                       | <b>22</b> |
| 10.1      | Maintenance interval .....                     | 22        |
| 10.2      | Filling internal refrigerant cylinder .....    | 22        |
| 10.3      | Self test .....                                | 23        |
| 10.4      | Pressure zero .....                            | 23        |
| 10.5      | Counters .....                                 | 23        |
| 10.6      | Long life pump test .....                      | 23        |
| 10.7      | Vacuum pump oil change .....                   | 24        |
| 10.8      | Replace filter dryer .....                     | 24        |
| 10.9      | Printer maintenance (optional) .....           | 25        |
| 10.10     | Periodic checks .....                          | 25        |
| <b>11</b> | <b>Spare parts</b> .....                       | <b>26</b> |
| <b>12</b> | <b>Maintenance</b> .....                       | <b>27</b> |
| 12.1      | Vacuum pump oil change .....                   | 27        |
| 12.2      | Filter dryer change .....                      | 29        |
| 12.3      | Refrigerant load cell calibration check .....  | 32        |
| 12.4      | Other checks/maintenance/repairs .....         | 33        |
| 12.5      | Notes .....                                    | 35        |

# 1 Symbols use

## 1.1 In the documentation

### 1.1.1 Warning notices- Structure and meaning

Warning notices warn of dangers to the user or people in the vicinity. Warning notices also indicate the consequences of the hazard as well as preventive action. Warning notices have the following structure:

|                |  |
|----------------|--|
| Warning symbol | <b>KEYWORD - Nature and source of hazard!</b><br><b>Consequences of hazard in the event of failure to observe action and information given.</b><br><b>►Hazard prevention action information.</b> |
|----------------|--|

The key word indicates the likelihood of occurrence and the severity of the hazard in the event of non-observance:

| Keyword        | Probability of occurrence           | Severity of danger if instructions not observed |
|----------------|-------------------------------------|---|
| <b>DANGER</b>  | <b>Immediate impending danger</b>   | Death or severe injury                          |
| <b>WARNING</b> | <b>Possible impending danger</b>    | Death or severe injury                          |
| <b>CAUTION</b> | <b>Possible dangerous situation</b> | Minor injury                                    |

### 1.1.2 Symbols in this documentation

| Symbol   | Designation                 | Explanation   |
|----------|-----------------------------|---|
|          | <b>Attention</b>            | Warns about possible property damage                              |
|          | <b>Information</b>          | Practical hints and other useful information.                     |
| 1.<br>2. | <b>Multi-step operation</b> | Instruction consisting of several steps.                          |
|          | <b>One-step operation</b>   | Instruction consisting of one step.                               |
|          | <b>Intermediate result</b>  | An instruction produces a visible intermediate result.            |
|          | <b>Final result</b>         | There is a visible final result on completion of the instruction. |

## 1.2 On the product

Observe all warning notices on products and ensure they remain legible.



► Wear protective goggles.



► Wear protective gloves.

# 2 Important notes



Before start up, connecting and operating MAHLE products it is absolutely essential that the Original instructions/owner's manual and, in particular, the safety instructions are studied carefully. By doing so you can eliminate any uncertainties in handling MAHLE products and thus associated safety risks upfront; something which is in the interests of your own safety and will ultimately help avoid damage to the device. When a MAHLE product is handed over to another person, not only the Original instructions but also the safety instructions and information on its designated use must be handed over to the person.

## 2.1 User group

The product may be used by skilled and instructed personnel only. Personnel scheduled to be trained, familiarized, and instructed or to take part in a general training course may only work with the product under the supervision of an experienced person. All work conducted on pressurized equipment may be performed by persons with sufficient knowledge and experience in the field of refrigeration, cooling systems and coolants and, also be aware of the risks involved in the use of pressurized devices

## 2.2 Agreement

By using the product you agree to the following regulations:

### Copyright

Software and data are the property of MAHLE or its suppliers and protected against copying by copyright laws, international agreements and other national legal regulations. Copying or selling of data and software or any part thereof is impermissible and punishable; in the event of any infringements MAHLE reserves the right to proceed with criminal prosecution and to claim for damages.

## Liability

All data in this program is based—where possible—on manufacturer and importer details. MAHLE does not accept liability for the correctness and completeness of software and data; liability for damage caused by faulty software and data is ruled out. Whatever the event, MAHLE liability is restricted to the amount for which the customer actually pays for the product. The disclaimer of liability does not apply to damages caused by intent or gross negligence on the part of MAHLE.

## Warranty

Any use of non-approved hardware and software will result in a modification to our product and thus to exclusion of any liability and warranty, even if the hardware or software has in the meantime been removed or deleted.

No changes may be made to our products. Our products may only be used in combination with original accessories and original service parts. Failing to do so, will render null and void all warranty claims.

This product may only be operated using MAHLE approved operating systems. If the product is operated using an operating system other than the approved one, then our warranty obligation pursuant to our supply conditions will be rendered null and void. Furthermore, we will not be held liable for damage and consequential damage incurred through the use of a non-approved operating system.

## 2.3 Obligation of contractor

The contractor is obliged to ensure that all measures geared towards the prevention of accidents, industrial diseases, labor-related health risks are taken and measures towards making the workplace fit for people to work in are carried out.

### Basic rules

The contractor is bound to ensure that all electrical equipment and operating material is set up, modified and maintained by skilled electricians only or under the guidance and supervision of a skilled electrician in accordance with electrical engineering principles.

Furthermore, the contractor must ensure that all electrical equipment and operating material is operated in keeping with electrical engineering principles.

If a piece of electrical equipment or operating material is found to be defective, i.e. It does not or no longer complies with electrical engineering principles, the contractor must ensure that the fault is rectified immediately and, in the event that imminent danger exists, also ensure that the electrical equipment or the electrical operating material is not used.

### Tests (taking Germany as an example)

- The contractor must ensure that all electrical systems and equipment are tested by a qualified electrician or under the guidance of a qualified electrician to ensure they are in proper working order:
  - Before starting for the first time.
  - After modifications or repairs before starting
  - At given intervals. Set intervals such as to ensure that faults that can be expected to occur are determined in good time.
- The test is to take the electrical engineering principles relating hereto into account.
- Upon request of the free trade association, a test manual is to be maintained into which specific entries are made.

## 2.4 Safety regulations

### 2.4.1 ACX2150

Always carefully study and follow all the safety regulations before using the MAHLE product.



Avoid all skin contact with the refrigerant. The low boiling point of the refrigerant (approx. -30° C) can lead to frostbite. Should refrigerant come into contact with the skin, remove any moistened clothing immediately and rinse the area of skin affected with generous amounts of water.

- Avoid all skin contact with the UV dye. Should UV dye come into contact with the skin, remove any moistened clothing immediately and rinse the area affected with generous amounts of water.
- R134a is colorless, with weak characteristic smell and heavier than air. It may flow into repair pits. Should refrigerant escape, Provide for sufficient ventilation (particularly in repair pits) and leave the workshop.



Never inhale refrigerant, dye and oil vapors. The vapors can irritate the eyes, nose and respiratory system. If liquid refrigerant or UV dye comes into contact with the eyes, rinse them thoroughly with water for 15 minutes. Then obtain medical attention even if no pain is felt

- Never swallow UV dye. Should it be swallowed inadvertently, never attempt to induce vomiting. Drink generous amounts of water and obtain medical attention.
- Before connecting the ACX2150 to a vehicle air conditioning system or an external refrigerant bottle, make sure the quick-release couplings are not leaking. Only ever use external refrigerant bottles provided with safety valves and certified in line with applicable standards.
- Before switching off the ACX2150, make sure all charging and drainage operations have been completed. This prevents damage to the unit and reduces the risk of refrigerant escaping into the environment.



Never use compressed air with R134a. Certain mixtures of air and R134a are highly flammable. Such mixtures are a potential hazard and may lead to fire or explosions and thus cause damage or injury.

- Refrigerant extracted from a vehicle air conditioning system may be contaminated with moisture, lubricant, dirt and traces of other gases.
- If the refrigerant has been contaminated by being mixed with other gases, remove the contaminated refrigerant and add fresh R134a before using the ACX2150 for A/C service.
- R134a is not to be used in areas in which there is a danger of explosion. Fire, open flames and smoking are prohibited.
- The ACX2150 unit should not be exposed to excess moisture or be operated in wet areas

- R134a is not to be mixed with other refrigerants. The mixing of refrigerants could damage the vehicle air conditioning system.
- De-energizing is only to be performed by a qualified electrician, a qualified electrician for specific tasks (hybrid) or a power systems engineer.



If high-voltage components or high-voltage wires are handled incorrectly, there is a risk of fatal injury from high voltage and the possible transmission of current through the body.

- Work on vehicles with high-voltage components is only ever to be performed in a safe de-energized condition by persons with the minimum qualification "Trained to perform electrical work".
- Even after deactivating a high-voltage vehicle electrical system, the high-voltage battery may still be live.
- Operating condition cannot be established from any running noise, as the electric machine is silent when stationary. In gear positions "P" and "N" the engine or electric motor may start spontaneously depending on the charge of the high-voltage battery.
- Never open or damage high-voltage batteries.
- On vehicles that have been in an accident, never touch high-voltage components or exposed high-voltage wires before deactivating the high-voltage vehicle electrical system.
- The ACX2150 must be constantly monitored when in operation. Never leave the ACX2150 unattended when in operation. Vehicle A/C service using the ACX2150 must be prepared and implemented such that the vehicle air conditioning system circuit does not have to be opened (for example by removing the radiator or engine).
- Position the ACX2150 on all four wheels on a flat, vibration-proof surface so that proper operation of the scales is guaranteed
- Vehicle A/C service using the ACX2150 must be prepared and implemented such that the vehicle air conditioning system circuit does not have to be opened (for example by removing the radiator or engine).
- The ACX2150 can be secured in position by locking the caster brake.

- The ACX2150 must always be transported in its operating position. Never lay the ACX2150 on its side, as oil could then escape from the vacuum pump or the built in compressor could be damaged. There are no additional safety systems for protecting the ACX2150 against damage resulting from natural catastrophes.
- We recommend calibrating the scales at least once per year. Contact customer service for calibration of the scales.
- The ACX2150 must be subjected to regular maintenance by service personnel or authorized agents to ensure the safety of the unit.
- Disconnect power before performing any maintenance or service to unit.
- Never perform any maintenance work which is not expressly recommended in this manual. Contact customer service if components have to be replaced other than in the course of maintenance work.
- The ACX2150 must be connected to a properly grounded electrical connection.
- If there is damage to the ACX2150, terminate usage immediately and contact customer service.
- The service hoses and service quick-release couplings must be regularly checked for wear and replaced if damaged.
- The ACX2150 must be operated in an environment corresponding to the directive BGR 157 with respect to the exchange of air.
- Observe local laws or directives as to ensure the safety of the pressurized device.
- Follow the pertinent legal regulations or directives to ensure safe handling of pressurized devices.
- For safety reasons it is advisable to use a residual current operated circuit breaker (rccb) with the following specifications:

| Parameters             |                   |
|------------------------|-------------------|
| Rated voltage          | 110 VAC $\pm$ 10% |
| Rated frequency        | 50/60Hz           |
| Rated current          | 10A               |
| Rated tripping current | 30mA              |
| Tripping switch        | C                 |

- Never remove any components from inside the ACX2150 except for maintenance or repair purposes.
- Avoid using an extension cord with the unit. If necessary, use a good condition (three wire grounded, #14AWG or larger) extension cord of the shortest possible length. In addition, the current drawn by all devices connected to the wall socket must not exceed 15A total.



## 2.5 Safety devices

| Description     | Function  |
|-----------------|---|
| Pressure switch | Switches the compressor off in the normal operating pressure is exceeded                                |
| Safety valve    | The safety valve opens if the design pressure is exceeded   |
| Circuit Breaker | Interrupts the power supply if overcurrent is applied to the ACX2150                                    |
| Vents           | The ACX2150 is provided with vents in the housing to ensure the exchange of air even when switched off. |

## 2.6 Proper disposal

At the end of its service life, this equipment must be disposed of as follows:

- Contact the service center to have the refrigerant in the unit recovered and recycled.
- Consign the unit to an authorized collection center according to local legislation.

## 2.7 Recycled material disposal

- Return the refrigerant recovered from the unit to the refrigerant supplier for proper disposal or recycling.
- Lubricants extracted from the vehicle's A/C system must be returned to an official oil collection center

## 2.8 Packaging disposal

- ⚠ Electronic and electrical A/C service equipment must never be disposed of with domestic waste, but recycled appropriately.
- The packaging must be disposed of in conformity with local legislation.
- This contributes to protecting the environment

## 2.9 Disposal of combo filter

- Dispose of the filter via official collection points or in accordance with the local regulations. This contributes to protecting the environment

## 2.10 Technical Data

| Description                       | Specification  |
|-----------------------------------|--|
| R134a tank capacity               | 12L  |
| Service pressure                  | 400PSI   |
| Maximum content                   | 22lbs.   |
| Method to weigh gas content       | Load cell  |
| Recovered oil container           | 250ml  |
| Vacuum pump                       | 2CFM dual stage  |
| Vacuum pump oil quantity          | 250ml  |
| Compressor capacity               | 0.87cu in/14cc   |
| Dryer filter                      | 68kg recovered R134a                                   |
| Non-condensable gas purge         | Automatic via solenoid valve                           |
| HP and LP taps                    | Automatic  |
| Display                           | 7 inch capacitive touch screen                         |
| Software updating                 | USB type A or USB type B direct connect to PC          |
| Printer (optional)                | Thermal, 24 columns                                    |
| All functions                     | Automatic and manual                                   |
| Recycling mode                    | Single pass  |
| Memory for customized cycles      | 100 records  |
| Flushing                          | With integrated solenoid valves                        |
| System pressure diagnostics       | Manual and automatic                                   |
| Dryer filter replacement alarm    | Active   |
| Vacuum pump oil replacement alarm | Active   |
| Full/empty tank check alarm       | Active   |
| Full oil container check alarm    | Visual   |
| Empty oil container alarm         | Visual   |
| Dimension H x W x D               | 119 x 74 x 74 cm                                       |
| Dry weight                        | 98kg   |
| Power supply frequency            | 60Hz   |
| Voltage                           | 120VAC, 1 phase  |
| Total max load                    | 7.5A   |
| Overcurrent protection            | 12A (circuit breaker)                                  |
| Operating temperature             | 50 - 122°F   |
| Humidity                          | 10 - 90%RH (non-condensing)                            |
| Storage temperature and humidity  | -13 to 50°F<br>10 - 90%RH (non-condensing)             |
| Max operating altitude            | 6562 ft.   |
| Pollution degree                  | 2  |
| Water degree                      | 0  |
| Certifications                    | SAE J2788<br>UL 1963<br>CAN/CSA STD C22.2NO. 120 – M91 |

## 2.11 Glossary

- **Recovery phase:** The refrigerant is extracted from the vehicle air conditioning system, cleaned and routed into the internal bottle of the ACX2150. The refrigerant oil collected in the process is drained into the used oil bottle at the ACX2150.
- **Vacuum phase:** A vacuum is generated in the vehicle air conditioning system. Measurement of the drop in pressure begins as soon as the vacuum has been generated.
- **Charging phase:** A certain quantity of refrigerant is added to the vehicle air conditioning system.



## 3 Product description

### 3.1 Application

ACX2150 is suitable for vehicles with a conventional engine as well as for hybrid and electric vehicles. ACX2150 features all the functions required for vehicle A/C service.

The following functions can be implemented:

- Refrigerant recovery and recharging.
- Vacuum generation.
- Flushing.

 The ACX2150 can only be operated with R134a. The ACX2150 is not to be used for service work on vehicles with air conditioning systems employing refrigerants other than R134a, as this will cause damage. Prior to A/C service check the type of refrigerant used in the vehicle air conditioning system.

### 3.2 Scope of delivery

| Description                             |
|---|
| Service hose (high pressure)            |
| Service hose (low pressure)             |
| Quick-release coupling (high pressure)  |
| Quick-release coupling (low pressure)   |
| Used oil bottle                         |
| New oil bottles (2)                     |
| Original instructions                   |
| Adapter (external bottle) - US Acme 1/2 |
| Calibration check weight                |

## 4 Description of unit



**Fig. 1: Front Right View**

1. Rear Handle
2. Tool Tray
3. Status indicator light
4. LCD display
5. Low Pressure Gauge
6. High Pressure Gauge
7. Front Cover
8. Locking Caster
9. Rear Wheel
10. Printer (optional)
11. Used oil bottle
12. PAG oil bottle

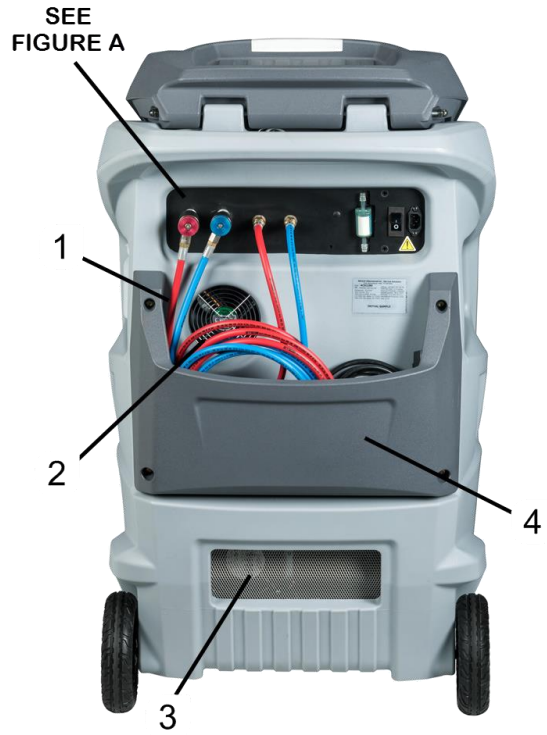

**Fig. 2: Rear View**

1. Service Hoses
2. Fan
3. Vent
4. Hose Storage

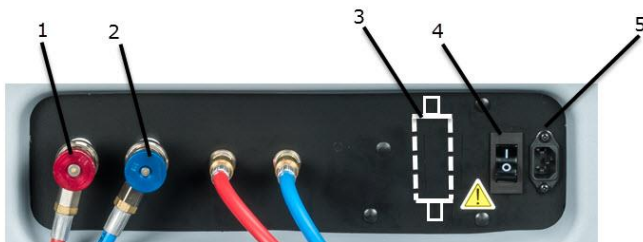

**Figure A: Rear Connection View**

1. High Side Parking Coupler
2. Low Side Parking Coupler
3. Refrigerant Identifier (Optional)
4. Power Switch with circuit breaker
5. Power Cord socket

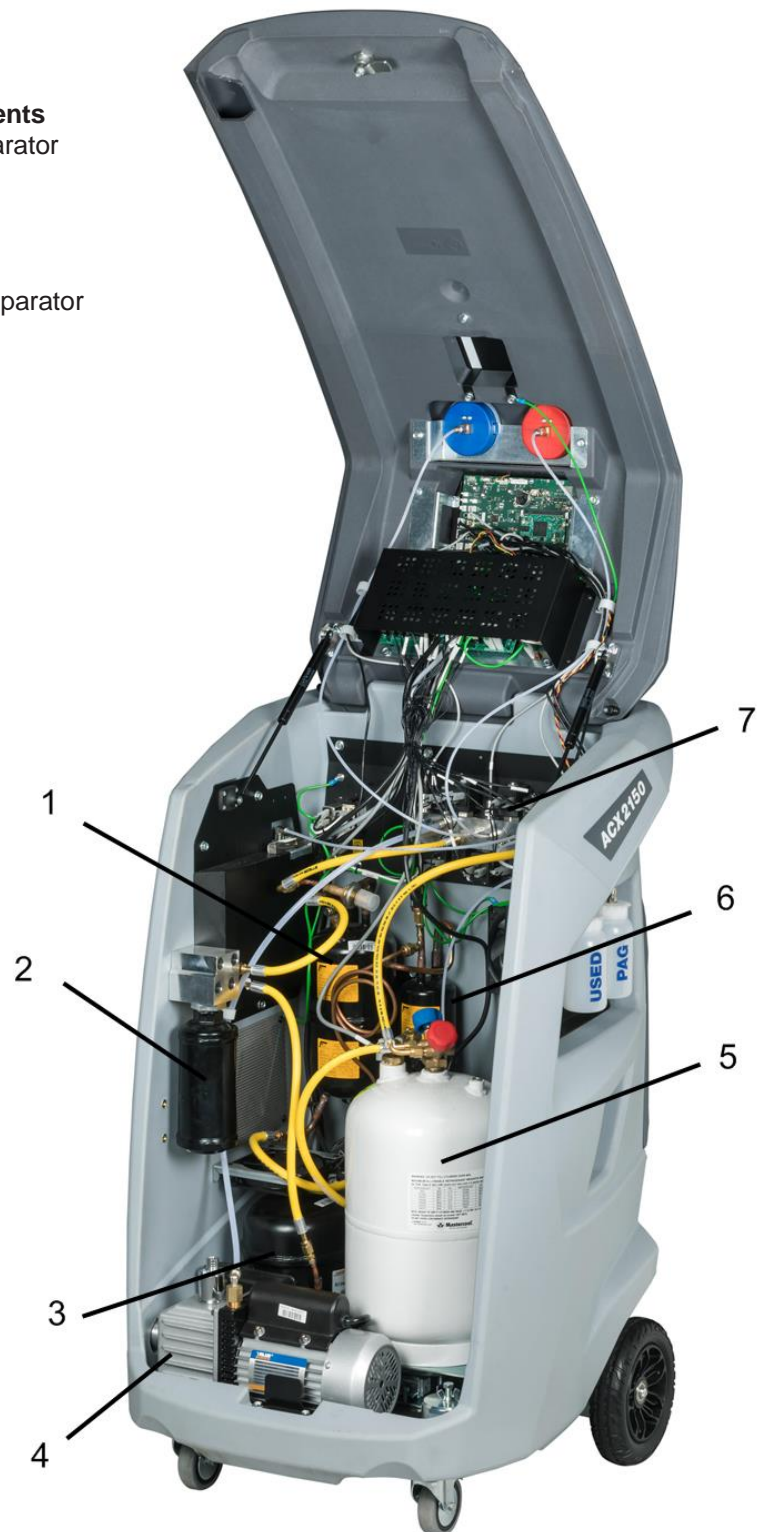

**Fig. 3 Front Left view**

1. UV fluid bottle
2. Vacuum pump oil level sight glass

**Fig. 4: Internal components**

1. Accumulator/Oil Separator
2. Combo filter
3. Compressor
4. Vacuum pump
5. Refrigerant tank
6. HS compressor oil separator
7. Manifold



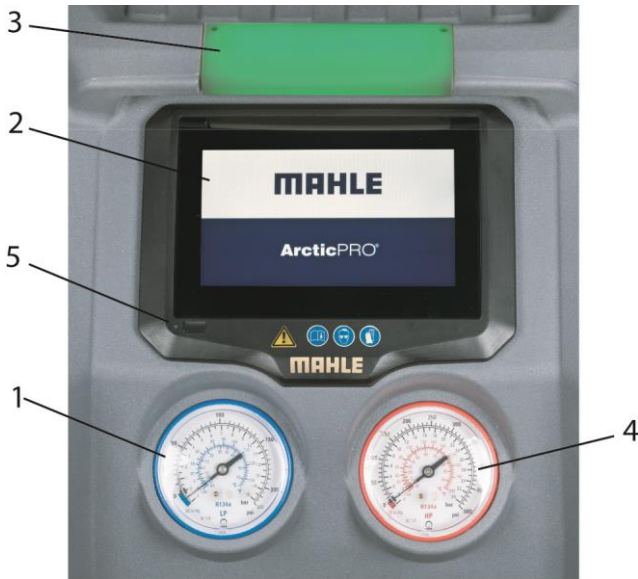

**Fig. 5: Display and operating unit**

1. Low Side pressure gauge
2. LCD Touch Screen
3. Status and warning indicator light
4. High Side pressure gauge
5. USB port

The menu selection and necessary entries are made by way of the LCD touch screen (Fig. 5, Pos. 2) integrated in the panel.

The pressure gauges (Fig. 5, Pos.1,4) of the display and operating unit are used to monitor the pressure during the individual vehicle A/C service phases. The status of the various service phases during maintenance is displayed on the LCD screen (Fig. 5, Pos. 2).

The status and warning indicator light (Fig. 5 Pos. 3) indicates the service status. See chart below for further definition.

| Status and warning light color | Maintenance status                    |
|--------------------------------|---------------------------------------|
| Red Light                      | Error/warning                         |
| Flashing green                 | Operation in progress                 |
| Green light                    | Operation complete/Attention Operator |

## 5 Input Selection

### 5.1 Selection and function key

All settings, controls and service functions are available on the LCD touch display. Data entry and moving of the cursor is performed with user's finger or another object such as a pen or stylus. The LCD displays the service equipment's status, the progress of A/C system service and any alarms/error messages.

 Do not use a sharp, pointed object on the touch screen. Damage may occur!

 Although the LCD touch screen is glass, do not use harsh chemicals to clean the surface. Standard glass cleaner is recommended

To select a function in the menu, press the text name of the function and the selection occurs when finger is released. The selected entry is highlighted with a different color (from blue to gray) and the menu screen pages changes.

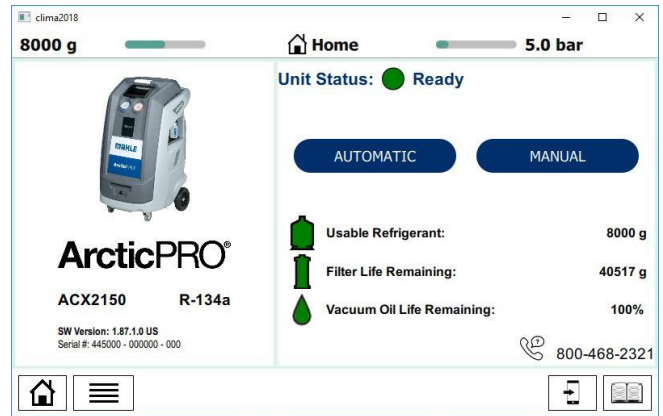

**Fig. 6: ACX2150 Home Screen**

If there are menus that cannot fit on one screen, there will be arrows located on a side of the screen. By placing finger on screen and swiping left/right, the screen options will also move.

## 5.2 Display screen

When unit loads, the home screen will be displayed (Fig. 6). This screen is accessible by pressing (  ) button in lower left corner of the screen.

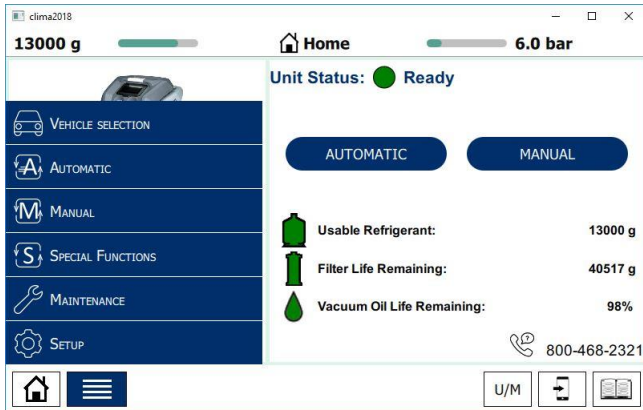





Fig. 7: ACX2150 Menu Selections

An Automatic or Manual process can be selected by touching the word on the upper right side of the screen or by touching the  (MENU) button in the lower left corner of the screen and selecting which type of process is desired.

 To select a function in the menu, touch finger to option.

 If you need to enter free text, the numerical keypad can be used.

## 5.3 Main Menu Options

The main menu of the graphical user interface allows user to select the following functions:

- Vehicle Selection
- Automatic
- Manual
- Special functions
- Maintenance
- Setup

Each of the menu options will be described in detail later in the manual.

## 5.4 Unit Features

### 5.4.1 EcoLOCK® couplers (optional)

EcoLOCK® is the intelligent coupler that with the suitable automated procedure in the software enables to:

- Reduce the amount of non-condensable gases formed inside the cylinder
- Avoid the refrigerant (loss) dispersion in the air during the disconnection of the couplers (Puff-effect)
- Check possible Schrader valve leaks before disconnection



Fig. 8: EcoLOCK® Couplers

To connect the coupling, position the coupling on the parking coupler, pull back the knurled section of the coupling element and press carefully onto the connection (Fig. 9).

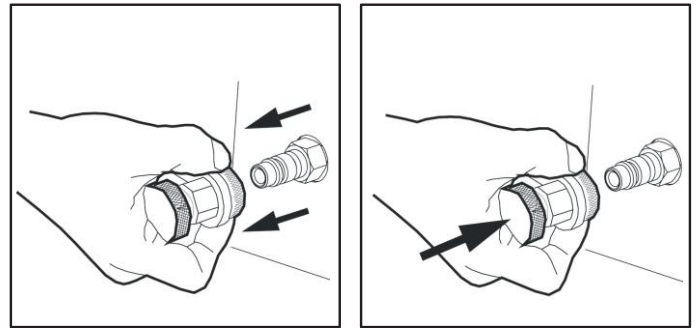



Fig. 9: Fastening quick release coupling

-  The service quick-release couplings are connected to the service connections of the vehicle air conditioning system during A/C service. When not in use, the service quick-release couplings can be connected to the parking/flush couplers
-  To remove the service quick-release couplings from the park coupler, press the coupling slightly towards the connection and carefully pull the knurled section back to unfasten it from the coupler.

### 5.4.2 Locking caster brakes

Rolling of the ACX2150 can be prevented by locking the caster brakes (Fig. 1, Pos. 8) at the front wheels.

### 5.4.3 Power supply cable and switch

The power supply cable is connected to the main power input. When not in operation, the power supply cable can be disconnected and hung on the handle. The ACX2150 is switched on by toggling the rocker switch to the on position.



## 5.5 Functional description

The refrigerant recovered from the air conditioning system pass through the combo filter to remove suspended particles and moisture.

The purpose of the vacuum pump is to generate a vacuum in the air conditioning system which removes excess moisture and to detect possible leaks in the vehicle air conditioning system.

Used oil is separated from the recovered vehicle refrigerant and drained into the used oil bottle.

The vehicle air conditioning system is partly filled with UV dye to facilitate the detection of leaks in the event of damage to the vehicle air conditioning system.

The refrigerant in the internal refrigerant bottle is used for filling the vehicle air conditioning system.

The purging unit for the non-condensable gases, consisting of a temperature sensor, pressure sensor, coil and orifice always takes effect when the internal refrigerant bottle pressure is higher than the saturation pressure

## 6 Equipment installation

### 6.1 Unpacking ACX2150



Warning – Risk of personal injury!  
Incorrect handling could cause equipment to overturn.



The manufacturer disclaims all responsibility for damage to objects and/or persons resulting from the equipment being wrongly removed from the pallet, or if the operation is performed by unsuitable personnel, with improper means protections and without complying with the existing laws on manual handling of loads and with the operations described in this manual.



- Remove staples and remove the carton (Fig. 10)

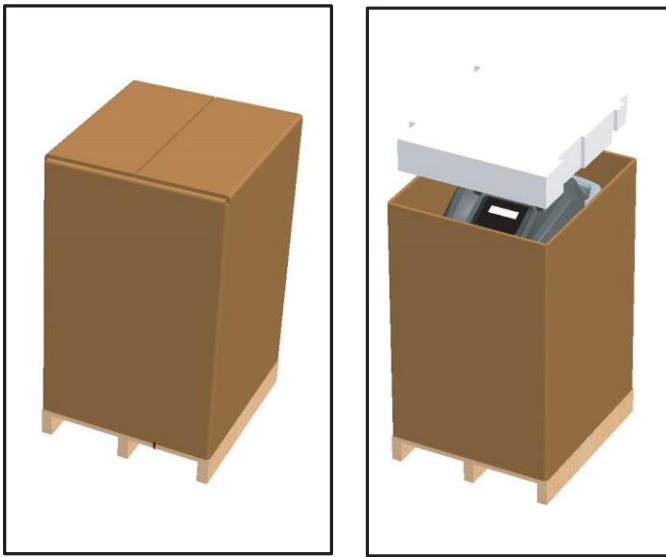

Fig. 10: Removing carton

- Cut straps securing unit to pallet.
- With 2 people, lift both front wheels by levering with the handle so unit is setting on the rear wheels (Fig. 11).

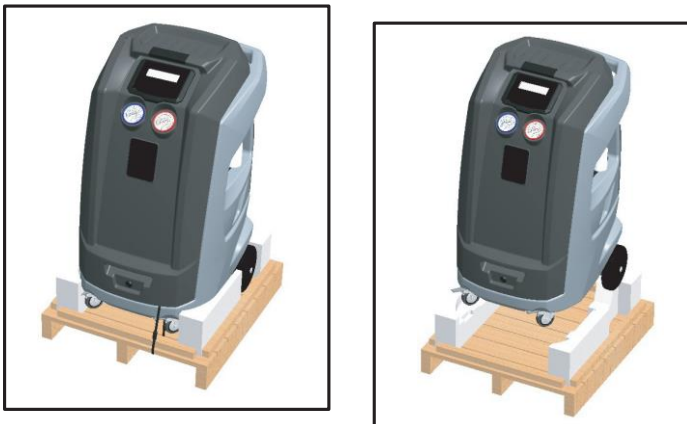

Fig. 11: Tilting unit backwards

- Slowly lower the unit from pallet by means of the rear wheels (Fig. 12).



Fig. 12: Lowering unit from the pallet

- Keep the pallet, carton, and scratch protection film for use in case of a need to return unit.



## 7 Commissioning

- i** All the operations described in Section 7 must be performed prior to first A/C service

### 7.1 Connections and positioning

- ⚠** The ACX2150 is designed for 110V, 50/60Hz. Follow the information on the ACX2150 rating plate.

- 1 Set the ACX2150 on a flat, vibration proof surface.
- 2 Actuate the caster brake to stop the ACX2150 from rolling.
- 3 Connect the power supply cable to the power supply.
- 4 Switch on the main switch.

- ⚠** The unit must be positioned on a stable, horizontal surface to ensure correct operation. Unit must be in an area with proper ventilation and at least 10cm from any potential obstacle to its internal ventilation.

- ⚠** Keep unit out of rain and excessive humidity as moisture could cause irreparable damage.

- ⚠** Prevent exposure to direct sunlight and excessive dust.

- ⚠** Unit must be properly grounded with the power plug ground pin. Failure to ground unit can cause damage and constitutes a risk of fatal injury or shock to the operator.

- i** Do not unplug any internal electrical connections and only have internal components opened and repaired by trained customer service personnel.

- i** Contact customer service in the event of any transportation damage (e.g. oil leakage).

- i** Leave quick couplings closed when unit is not in use and at end of vehicle service operations.

### 7.2 First start-up verification

#### Warning – Risk of frostbite from escaping refrigerant



Refrigerant causes frostbite on the skin

- Check the service hoses for damage
- Firmly connect the service quick-release couplings to the service hoses.
- Wear protective goggles.
- Wear protective gloves.

Execute the following actions in sequential order by following the procedure as shown on the display:

- Gas weight check (vacuums entire refrigerant circuit to ensure no contaminants are in system prior to filling)
- First internal cylinder fill

- i** It is possible to interrupt the initial check and print a report in which the status of the check is reported (if printer option was purchased).

- i** Equipment cannot operate in automatic mode until all the steps of initial check are completed.

1. Set the internal cylinder fill to desired quantity (min. 3kg).
2. Follow on-screen instructions.
3. Make sure hoses are disconnected from any external source at this time.
4. Start the procedure that initially creates vacuum in the internal refrigerant circuit (approximately 15 minute process).
5. Once message is displayed, the unit can be connected to the external cylinder and the valves opened.
6. Just before the targeted refrigerant amount is reached, unit will pause and prompt user to close external refrigerant tank connection.
7. Once this is done, the unit will continue to recover the refrigerant from the hoses and end once this is completed. The total amount recovered will then be displayed.

### 7.3 Setup

From the **SETUP** menu, it is possible to enable/disable and set certain parameters prior to performing A/C system service. To access **SETUP** from the main menu, press,  and the **SETUP** menu will be displayed.

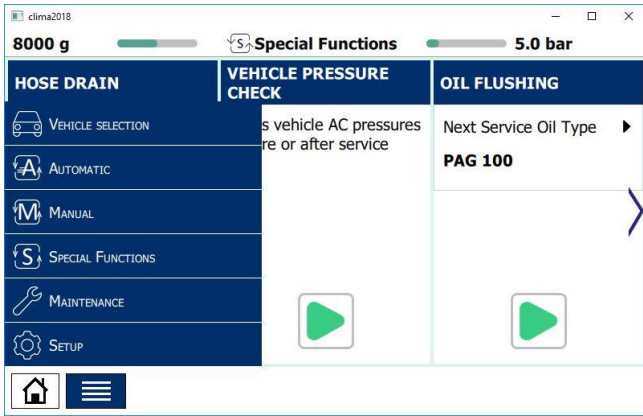

| Parameter            | Description  |
|----------------------|--|
| Wi-Fi                | Allows connection to wireless internet access                    |
| Print                | Provide print options  |
| Update               | Allows software updating   |
| Brightness           | Adjustment of screen backlight                                   |
| Maintenance Counters | Displays historical unit information                             |
| Units of measurement | Allows metric and empirical unit changes for all unit parameters |
| Account              | User information definitions                                     |
| Language             | Allows adjustment of user language on display                    |
| Remote Control       | Used for remote tech service diagnostics                         |
| System Information   | Displays all internal system information                         |
| Date and Time        | Adjustment of date and time                                      |
| Settings             | Allows enable and disable for selected functions                 |
| Configure            | Password protected service information                           |

- i** Check the type of source tank, 2 types are available:
  - **Refrigerant cylinder with plunger (typically 2 valves):**  
Connect to the liquid valve and keep tank in the upright position to transfer refrigerant.
  - **Refrigerant cylinder without plunger (single valve):**  
Connect to the available valve and invert tank to transfer refrigerant.

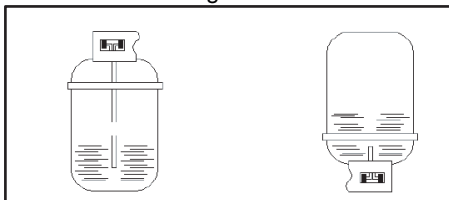

Fig. 13: Virgin refrigerant cylinder tank types

**i** The LP (blue) gauge indicates the pressure inside the external cylinder

### 7.4 Internal Bottle Fill



**Warning – Risk of frostbite from escaping refrigerant**

Refrigerant causes severe frostbite on the skin.



- Check the service hoses for damage.
- Firmly connect the service quick-release couplings to the service hoses.
- Wear protective goggles.
- Wear protective gloves.



- i** Before the ACX2150 can be used, the internal refrigerant bottle must be filled with liquid refrigerant. Use only R134a refrigerant.
- i** A menu-driven refrigerant check is performed before filling the internal refrigerant bottle.
- i** The refrigerant can be obtained from your gas supplier. It can be stored normally and transported in bottles with connection fittings.
- i** To ensure a reliable procedure, it is advisable to use the optimum quantity of refrigerant. The optimum quantity of refrigerant for the ACX2250 is 4kg – 9.5kg.
- i** An inadequate quantity may make efficient filling of the vehicle air conditioning system impossible. Also, if there is an insufficient quantity, the ACX2250 may not be able to operate efficiently. In the event of an excessive quantity, there may not be sufficient space for the refrigerant recovered from the vehicle air conditioning system.
- !** Generally speaking, the actual quantity of refrigerant added exceeds the set quantity by approx. 200g as there is no refrigerant in the internal refrigerant circuit. Add 200g to the set quantity when filling with refrigerant for the first time.

1. Select "Maintenance>>Internal bottle fill".

2. Follow the menu prompting.

The current pressure inside the external refrigerant bottle is indicated on the low-pressure gauge.

- i** Any amount of refrigerant between 200g and 10500g can be added.
- !** Do not interrupt the automatic filling process prior to automatic termination by the ACX2150.
- i** Press the Home key to check the quantity of refrigerant in the internal refrigerant bottle upon completion of the filling operation.

## 8 A/C service preparation

### 8.1 Preliminary preparation



**Warning - risk of burns from hot engine components**

**Contact with hot engine components will cause severe burns.**

- Allow the engine to cool down.
- Wear protective goggles.
- Wear protective gloves.



**Warning - risk of frostbite from escaping refrigerant**

**Refrigerant causes frostbite on the skin.**

- Check the service hoses for damage.
- Firmly connect the service quick-release couplings to the service hoses.
- Wear protective goggles.
- Wear protective gloves.



**⚠** Perform the following preparatory work prior to vehicle A/C service: Service hoses must be constructed of the proper materials and have the lengths as supplied by the unit. Hoses must have shut-off devices (quick-release couplers) at the connection point to the A/C to minimize the introduction of air into the ACX2150 and to minimize the amount of refrigerant released while disconnecting the hoses.

**⚠** Inspect hoses for signs of damage prior to performing A/C service. Use of damaged hoses will result in the loss of refrigerant and the possibility of refrigerant contamination.

**⚠** Follow the vehicle manufacturer's recommendations for A/C service on vehicles with a low-pressure connection only.

**⚠** A/C service operations (especially recovery) should be performed after the vehicle has been run for a period of time to allow engine heat to raise system pressure. This allows for the maximum refrigerant recovery amount to occur. If system is excessively hot, the recharge phase could be adversely effected.

**⚠** The ACX2150 is only to be operated with R134a refrigerant. Check with refrigerant is used for the vehicle before performing A/C service.

**⚠** Never attempt to close the valves of the internal refrigerant bottle while the ACX2150 is in operation.

**⚠** Only new lubricant as specified by the system manufacturer shall be installed in vehicle A/C system. Lubricant removed from the system and or equipment shall be disposed of in accordance with the applicable federal, state and local procedure and regulations.

**i** The service parameters (recharge quantity) can be found in the owner's manual or the vehicle repair manual.

### 8.2 Non-condensable gas discharge

If the ACX2150 detects non-condensable gases in the internal cylinder, the unit will prompt technician to allow unit to run an air purge. This prompt will occur every time unit is powered on (if unit has been powered off for at least 1 hour.)

**i** The process will perform automatically upon the start of a charge procedure if non-condensables are detected.

**i** Air purge is a necessary process to ensure ideal working parameters for the ACX2150. Presence of non-condensable gases will increase tank pressure and reduce efficiency of recharge cycles.

### 8.3 Charge Modes

**i** The ACX2150 has 2 different refrigerant charge methods. If charge does not complete using Quick mode, the zero tolerance method automatically commences

#### 8.3.1 Quick Modes

In Quick mode, the ACX2150 injects refrigerant through HP port. The refrigerant remains in the hoses at the end of the cycle and is then recovered during a hose clearing process.

#### 8.3.2 Zero tolerance mode

While the Zero tolerance mode is slightly longer in time, it provides a more accurate recharge and guarantees a successful charge.

**i** In Zero tolerance mode, the ACX2150 will by default charge through the HP (red) hose, then refrigerant that remains in the hoses is pulled into the vehicle's A/C system through the LP (blue) hose.

**i** In the instance where only a LP coupling is available for A/C service, the ACX2150 will charge the system with 50% of the total charge amount with the vehicle A/C compressor off. The unit then waits 10 minutes to allow the liquid refrigerant to evaporate to prevent damage to the compressor. The vehicle must be started and the A/C system turned on. The ACX2150 will continue to charge the refrigerant whenever the LP hose pressure is less than 3 bar.

## 9 A/C system service

### 9.1 Automatic cycle setup

Access to automatic cycles is available through the main menu by selecting **AUTOMATIC**.

Do not connect hoses/couplers to vehicle A/C system until prompted by the unit.

All values in the AUTOMATIC cycle mode are preset and unable to be modified from the Automatic menu, except for the refrigerant charge amount. If changing the value of the vacuum amount is desired, select a MANUAL process and choose all 3 services to be performed.

1. From the main menu, select AUTOMATIC.
2. Adjust the charge value to match that of the vehicle manufacturer's recommended value.

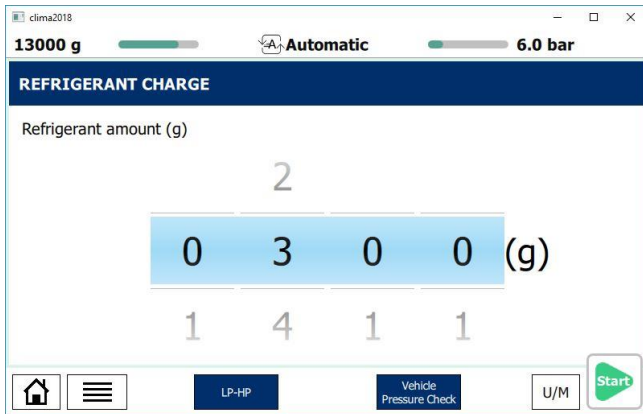

Fig. 14: Adjusting charge value

3. To change which hose the unit will charge, touch the blue box at the bottom of the screen that says LP-HP. A menu will pop up that allows technician to select which hoses/couplers to charge through.
4. If the technician wishes to perform a pressure check of the A/C system, they should select Vehicle Pressure check at the bottom of the screen. (When highlighted BLUE, the pressure check function is selected; when in GREY, the unit will not perform a pressure check.)
5. After options are properly adjusted, press the green arrow in the lower right corner of the screen.

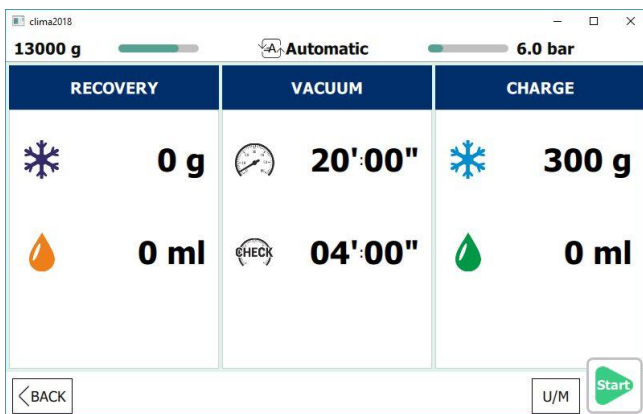

Fig. 15: Automatic setting confirmation

6. If settings are correct, press START button to begin process

### 9.2 Manual cycle setup

Access to manual cycles is available through the main menu by selecting **MANUAL CYCLES**.

Do not connect hoses/couplers to vehicle A/C system until prompted by the unit.

1. From the main menu, select MANUAL.

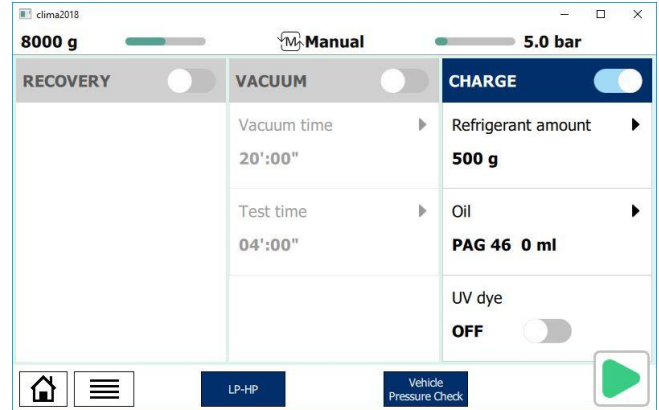

Fig. 16: Manual setting selection

2. Select the services desired by touching button at the upper right corner of each column. (Figure shows charge service selected)

See the sections about Recovery, Vacuum, and Charge on the next page for more detailed cycle setting information.

3. To change the charge hose, touch the blue box at the bottom of the screen that says LP-HP. A menu will pop up that allows technician to select which hoses/couplers to charge through.
4. If the technician wishes to perform a pressure check of the A/C system, they should select Pressure check at the bottom of the screen. (When highlighted BLUE, the pressure check function is selected; when in GREY, the unit will not perform a pressure check.)
5. After **options** are properly adjusted, press the green arrow in the lower right corner of the screen.
6. The unit will display a screen to confirm process settings. Press the START button to begin process.
7. Follow on-screen instructions to complete cycle.

### 9.3 Recovery process

1. From the main menu, select MANUAL, and then deselect all options except for RECOVERY.
2. To change the service hose, touch the blue box at the bottom of the screen that says LP-HP. A menu will pop up that allows technician to select which hoses to perform service through.
3. Press green arrow in lower right corner to begin service.
4. Follow on screen instructions to begin recovery process.

If no pressure is detected in the system, this function will not start. Technician should ensure couplers are open. If the system is empty, operator must exit and select a vacuum process.

There is potential for unit to display an error during this service for high internal pressure. This can occur due to high operating temperatures or hot refrigerant gasses entering the ACX2150

### 9.4 Vacuum process

1. From the main menu, select MANUAL, and then deselect all options except for VACUUM.
2. To change the service hose, touch the blue box at the bottom of the screen that says LP-HP. A menu will pop up that allows technician to select which hoses to perform service through.
3. To adjust vacuum time, touch in the VACUUM TIME box. The screen in Figure below will appear.

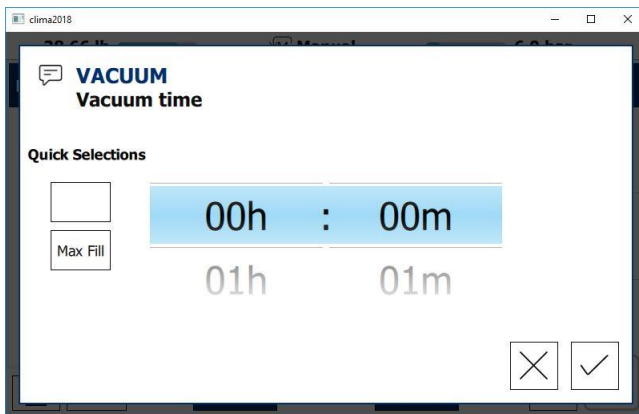

Fig. 17: Vacuum time adjustment

4. Swipe finger up or down to adjust the hours and minutes, then press the ✓ to accept or the X to cancel time adjustment.
5. If the vacuum test time needs adjusted, touch in the TEST TIME box.
6. Press green arrow in lower right corner to begin service.
7. Follow on screen instructions to begin vacuum process

### 9.5 Charge process

1. From the main menu, select MANUAL, and then deselect all options except for CHARGE.
2. To change the service hose, touch the blue box at the bottom of the screen that says LP-HP. A menu will pop up that allows technician to select which hoses to perform service through.
3. To adjust Charge amount, touch in the REFRIGERANT AMOUNT box. The screen in Figure below will appear.

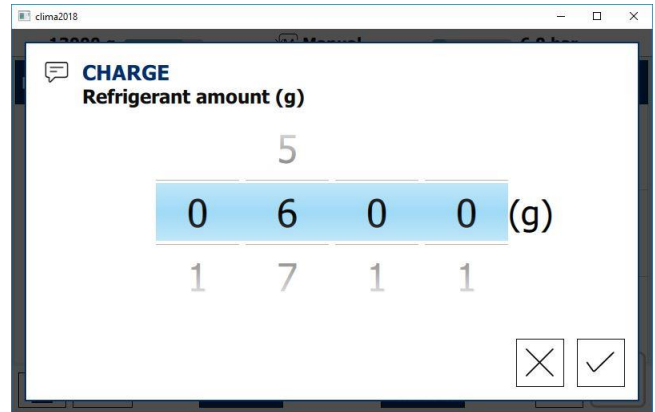

Fig. 18: Charge amount adjustment

4. Swipe finger up or down to adjust the refrigerant value to the vehicle manufacturer's recommended value, then press the ✓ to accept or the X to cancel time adjustment.
5. Then click the Oil amount box to adjust oil amount and type.

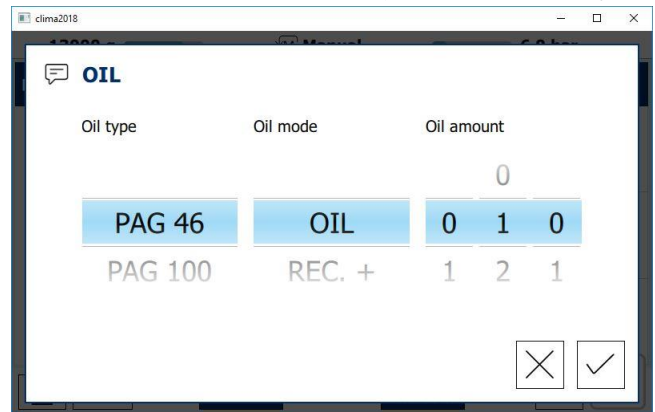

Fig. 19: Oil amount adjustment

6. Swipe finger up or down to adjust the oil values, then press the ✓ to accept or the X to cancel oil value adjustments.
7. If desired, turn the Tracer injection on to inject UV Dye into the vehicle A/C system.
8. Press the green arrow in lower right corner to begin service.
9. Follow on screen instructions to complete charge process.



### 9.6 Vehicle Pressure Check

- From the **MENU**, scroll to **SPECIAL FUNCTIONS** and select. The **SPECIAL FUNCTIONS** screen will now be displayed.

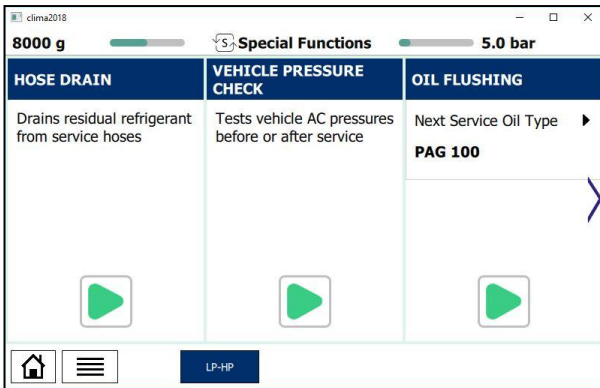

Fig. 20: Vehicle pressure check

- This will test vehicle A/C pressures before and after service

### 9.7 Unit of measure

- From the **SETUP** menu, scroll to **UNITS OF MEASURE**.
- The user has the option of selecting the units of measure for:
  - Weight
  - Temperature
  - Pressure
  - Volume

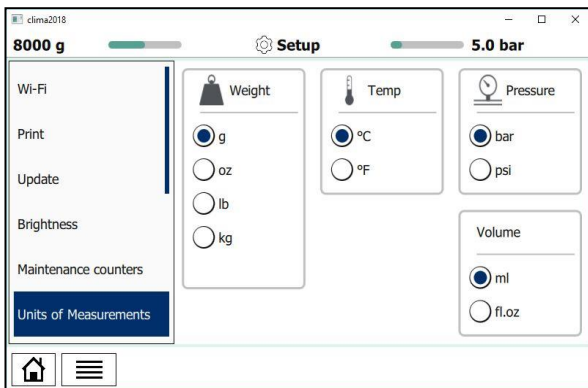

Fig. 21: Unit of measure

### 9.8 Clock Adjustment

- From the **SPECIAL FUNCTIONS** menu, scroll to **SET UP** and select **DATE AND TIME**.
- The operator can now scroll to the desired date and time settings.
- After selection is complete, press save.

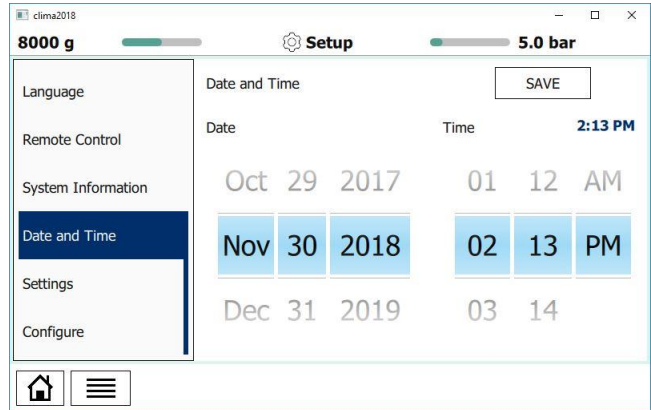

Fig. 22: Clock Adjustment

### 9.9 Setting language

- From the **SETUP** menu, scroll to **LANGUAGE**
- The user now has the option of seven language selections.
- Scroll to the desired language and select.
- Press **SET LANGUAGE** to save your selection.

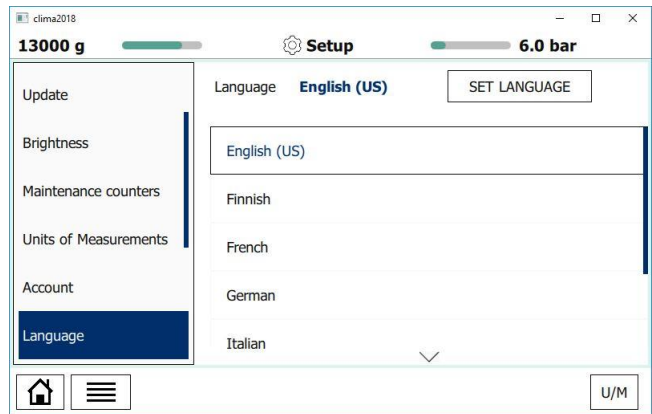



Fig. 23: Language

# 10 Maintenance

- ❗ Please contact an authorized technical service center for purchasing factory replacement parts.

## 10.1 Maintenance interval

| Description                                      | Period                              |
|--|-------------------------------------|
| Calibration of scales                            | 1x per year to ensure accuracy      |
| Vacuum pump oil replacement and system leak test | After 1000 hours of service         |
| Combo filter replacement and system leak test    | After 75kg of refrigerant processed |
| System leak test                                 | As required                         |

- ⚠ Make sure ACX2150 is disconnected from power before removing plastic housing.
- ⚠ Never perform any maintenance work which is not expressly recommended in this Section.
- ⚠ Contact customer service if components have to be replaced other than in the course of maintenance work.
- ❗ To access MAINTENANCE from the MAIN MENU, press  and scroll to MAINTENANCE and then select.

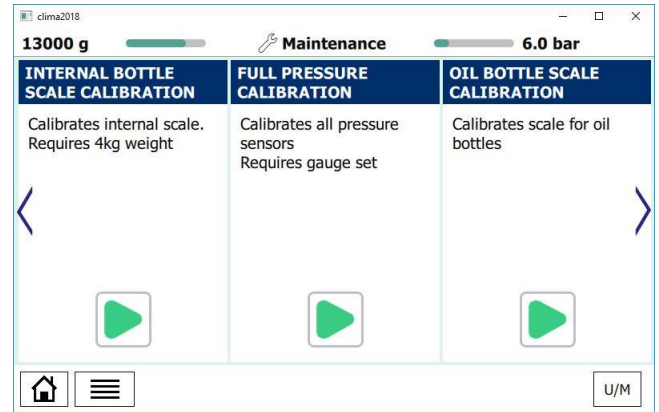
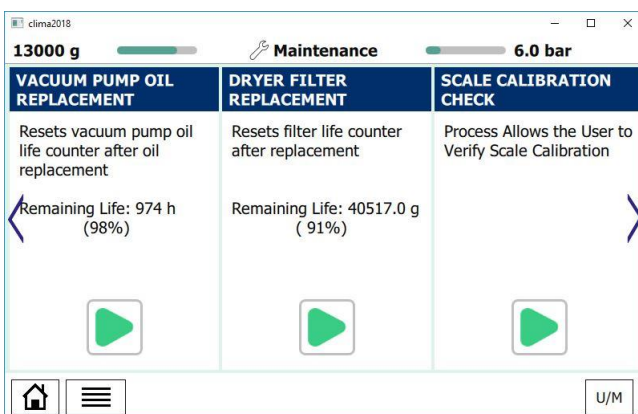
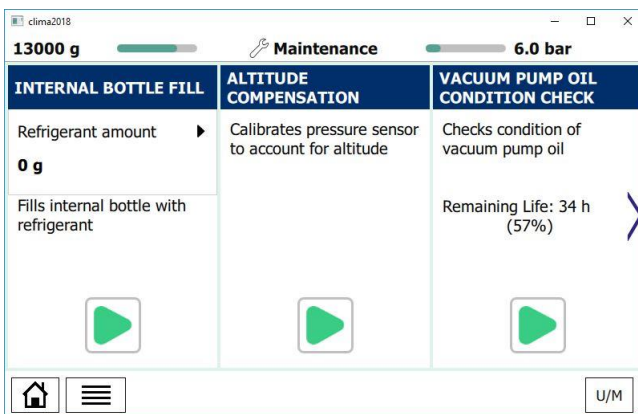

Fig. 24: Maintenance screens

## 10.2 Filling internal refrigerant cylinder





### Warning - Risk of frostbite from escaping refrigerant

**Refrigerant causes severe frostbite on the skin.**

- ▶ Check the service hoses for damage.
- ▶ Firmly connect the service quick-release couplings to the service hoses.
- ▶ Wear protective goggles.
- ▶ Wear protective gloves.



❗ Before the ACX2150 can be used, the internal refrigerant cylinder must be filled with liquid refrigerant. Use only R134a refrigerant.

- ❗ The refrigerant can be obtained from your gas supplier. It can be stored normally and transported in bottles with connection fittings.
  - ❗ To ensure a reliable procedure, it is advisable to use the optimum quantity of refrigerant. The optimum quantity of refrigerant for the ACX2150 is 4kg – 10.0kg.
  - ❗ An inadequate quantity of refrigerant may make effectiveness of filling the vehicle air conditioning system impossible. Also, if there is an insufficient quantity, the ACX2150 may not be able to operate efficiently. In the event of an excessive quantity, there may not be space for the refrigerant recovered from the vehicle air conditioning system.
  - ⚠ Do not open coupler until unit prompts technician to open.
- From the **MAINTENANCE** menu, scroll until **INTERNAL BOTTLE FILL** is highlighted and press.
  - To adjust the charge amount, highlight the value and press   to adjust the value higher or lower.
  - Press the  to accept and begin process. or the X to cancel adjustment.
  - Follow the menu prompting.
- ❗ The current pressure inside the external refrigerant bottle is indicated on the low-pressure gauge.
  - ❗ Do not interrupt the automatic filling process prior to automatic termination by the ACX2150.



### 10.3 Self test

**i** This test is designed to check the internal ACX2150 circuit for any leaks.

To perform Self test:

1. From the **MAINTENANCE** menu, scroll until **SELF TEST** is highlighted and press.
2. Allow unit to perform test to completion.

**i** If a test fails, check charge hoses and quick couplers for leaks first. If repair is possible, fix the leak and repeat test.

### 10.4 Pressure zero

**i** This function allows technician to determine and store the atmospheric pressure value.

This procedure should be performed everytime the ACX2150 is moved from one location to another that has a different altitude

1. From the **MAINTENANCE** menu, scroll until **PRESSURE ZERO** is highlighted and press arrow.

### 10.5 Counters

**i** These screens will display the vacuum pump and compressor hours of life and the remaining time before vacuum pump oil and the filter dryer need replacement.

1. From the **MAINTENANCE** menu, scroll until **MAINTENANCE COUNTERS** is shown and make selection.
2. Press **↓↑** to display all counters.

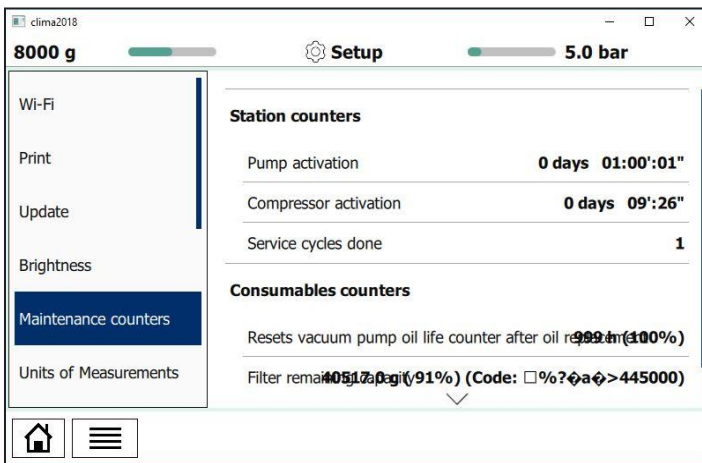

Fig. 25: Maintenance counters

### 10.6 Long life pump test

**i** The Long Life Pump function equipped on the ACX2150 enables the unit to optimize the vacuum pump oil use and avoid the need to replace after every 60 hours of operation.

1. After the first 60 hours of vacuum pump operation, check the vacuum pump oil level and top off if necessary.
2. From the **MAINTENANCE** menu, scroll until **LONG LIFE PUMP TEST** is highlighted and press arrow.
3. The process will run for approximately 1 hour.

**i** During this process, the vacuum pump oil is automatically purified from the gaseous residues absorbed by the oil during the vacuuming of vehicle A/C systems.

4. At end of procedure, vacuum pump performance check is executed and the result is displayed on the display.

**i** If the result of the Long Life Pump test is negative, the oil must be changed.

**i** If the results pass, the pump oil remaining time will change to 1000 hours. After 1000 hours of runtime, the oil must be changed.

## 10.7 Vacuum pump oil change

**i** After 60 hours of runtime (or 1000 hours if the Long Life Pump test is completed successfully), the vacuum pump oil must be replaced.

1. Disconnect ACX2150 from power.
2. Using a flathead screwdriver, rotate the front locking screw and lift the front housing.

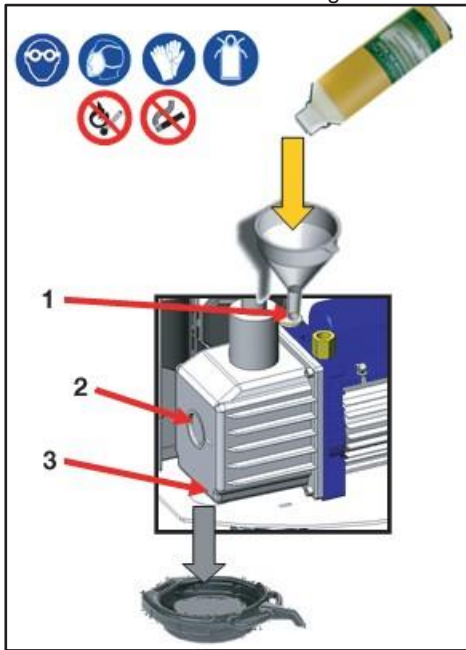

**Fig. 26: Changing vacuum pump oil**

- 1 Oil filling plug
- 2 Oil inspection window
- 3 Lower drain plug

3. Place a bowl under the vacuum pump oil drain hole. Remove the upper filling plug and the lower drain plug to allow the oil to drain from unit.
4. Once the pump has been emptied, reinstall the lower drain plug.
5. Fill the pump with new oil through the upper fill port using a funnel if needed. Fill until the oil appears halfway up the oil level inspection window.
6. Once the pump has been filled, reinstall the upper fill plug.
7. Close front housing and secure locking screw.
8. Connect to power and turn on.
9. From the **MAINTENANCE** menu, press **↓↑** until **PUMP OIL REPLACEMENT** is highlighted and press arrow. Press the **RESET** key to set the counter. The level and clearness of the vacuum pump oil can be checked by removing the rubber plug located on the front-left side of the unit.

## 10.8 Replace filter dryer



**Warning - Risk of frostbite from escaping refrigerant**

**Refrigerant causes severe frostbite on the skin.**



- ▶ Check the service hoses for damage.
- ▶ Firmly connect the service quick-release couplings to the service hoses.



- ▶ Wear protective goggles.
- ▶ Wear protective gloves.

- i** Unit operation is disabled at the end of the filter service life. Each filter is marked with a unique code. This code must be entered when replacing the filter. It is not possible to operate the ACX2150 if the same code is re-used. It is advisable to keep a supply of filters in stock to avoid downtimes due to the unit being disabled.
- i** The ACX2150 is disabled once 68kg (150lb) of R134a refrigerant has passed through the filter. A new filter must be installed and its unique code entered in the ACX2150 before vehicle A/C service can be performed.

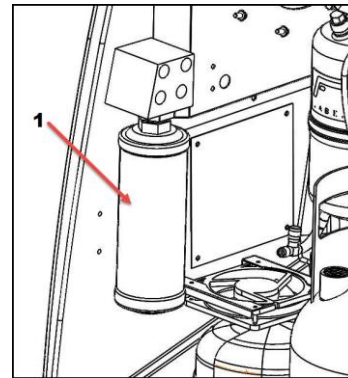

**Fig. 27: Changing filter dryer**

- 1 Filter dryer

1. To begin the filter replacement process, from the **MAINTENANCE** menu, scroll until **FILTER REPLACEMENT** is highlighted and press arrow.
2. Insert the new filter code using the keypad.
3. Using a flathead screwdriver, rotate the front locking screw and lift the front housing.
4. Verify that the 2 o-rings are included and positioned correctly prior to attaching to housing.
5. Loosen the filter using a 1-3/8" (35mm) wrench.
6. Remove the filter
7. Insert a new filter
8. Tighten the filter to 74 ft-lbs (100N-m)
9. Carefully close front housing and secure locking screw.
10. Allow unit to perform the automatic leak test requested by the software when unit loads

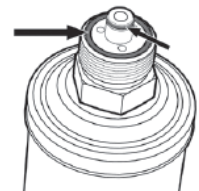

## 10.9 Printer maintenance (optional)

1. Open the lid of the printer as shown in Fig. 28

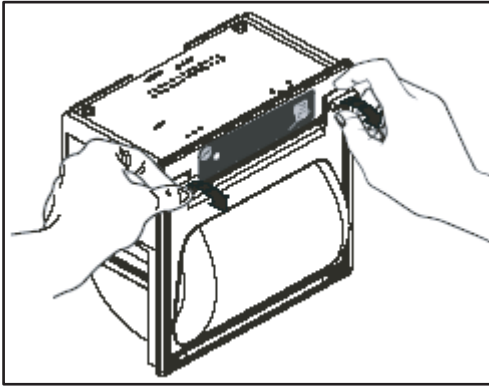

Fig. 28: Opening printer

2. Position the roll of paper inside the housing in the rotation direction indicated in Fig. 29.

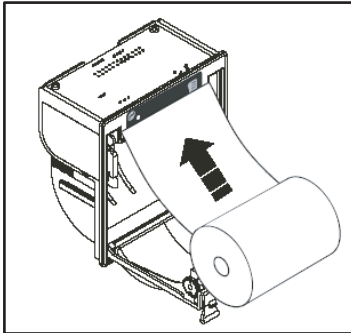

Fig. 29: Installing new paper roll

3. Pull the paper out of the housing as shown in Fig. 30 and close the lid.

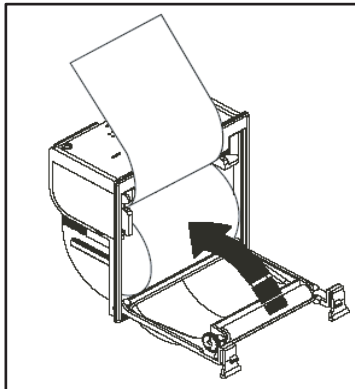

Fig. 30: Completing Installation

4. The printer is ready for printing

## 10.10 Periodic checks

- i The ACX2150 service station must be checked over regularly as set by local legislation.

- ⚠ The following checks should be performed to ensure safe and reliable operation:

- Make sure no corrosion or leakage is present in the internal cylinder and other metallic parts of the equipment (under normal conditions the internal cylinder life is at least 20 years).
- If automatic safety valve trips, contact technical support to have unit inspected, resolve any issues and replace valve if necessary.
- If the safety pressure switch trips, check the connection of the cables and correct connection to the PCB. Contact technical support for additional assistance.
- Check that external charging hoses - both red (HP) and blue (LP) - are in good order and undamaged. In the case of damaged hoses, discontinue use of ACX2150 until replacement hoses are procured.
- Verify that vacuum pump oil and filter dryer have been replaced according to schedule for proper functioning equipment.

# 11 Spare parts

| Description                            | Order number |
|--|--------------|
| Combo filter                           | 360 82739 00 |
| Vacuum pump oil                        | 011 80070 00 |
| Paper for printer (5 rolls)            | 360 83110 00 |
| Service hose (HP)                      | 028 80532 00 |
| Service hose (LP)                      | 028 80533 00 |
| Quick release coupling (HP)            | 023 80495 00 |
| Quick release coupling (LP)            | 023 80496 00 |
| Safety goggles (accessory item)        | 360 82956 00 |
| Protective gloves(accessory item)      | 360 82957 00 |
| Adaptor LP (external bottle) USACME1/2 | 023 80147 00 |
| Calibration Check Ball                 | 360 82744 00 |

**i** Additional spare/replacement parts are available through the service centers authorized by MAHLE or by its reseller. Contact technical support for replacement parts not listed above.





















# MAHLE

MAHLE Aftermarket Inc., Service Solutions  
10 Innovation Drive  
York, PA 17402  
USA

717-840-0678

[www.servicesolutions.mahle.com](http://www.servicesolutions.mahle.com)

035 82689 00  
2019-01-03